

221

FILE COPY NO. X	FILE COPY NO. 1
-------------------------------	--------------------



TECHNICAL MEMORANDUMS

NATIONAL ADVISORY COMMITTEE FOR AERONAUTICS

N

No. 839

THE DESIGN OF AIRPLANE-ENGINE SUPERCHARGERS

By Werner von der Nüll

Luftfahrtforschung
 Vol. 14, Nos. 4-5, April 20, 1937
 Verlag von R. Oldenbourg, München und Berlin

THIS DOCUMENT ON LOAN FROM THE FILES OF
 NATIONAL ADVISORY COMMITTEE FOR AERONAUTICS
 LANGLEY AERONAUTICAL LABORATORY
 LANGLEY FIELD, HAMPSHIRE, VIRGINIA

RETURN TO THE ABOVE ADDRESS
 REQUESTS FOR PUBLICATION SHOULD BE ADDRESSED
 AS FOLLOWS:

Washington
 October 1937

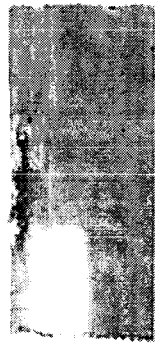

NATIONAL ADVISORY COMMITTEE FOR AERONAUTICS

TECHNICAL MEMORANDUM NO. 839

THE DESIGN OF AIRPLANE-ENGINE SUPERCHARGERS*

By Werner von der Nüll

Suitable superchargers for airplane engines are a requisite for successful high-altitude flying. The underlying principles for the computation and design of airplane-engine superchargers must be given further study. The results obtained through tests on the various forms of rotor vanes and counter vanes and on the design of the casing should prove useful for improvement of design. Well-known computation methods have shown themselves, with slight modifications, to be suitable. The use of single-stage centrifugal superchargers for supercharging to one atmosphere at 8 to 9 kilometers (25,000 to 29,000 feet) altitude appears, with suitable regulation, entirely possible without supercharger air cooling.

I. UNDERLYING POSSIBILITIES OF SUPERCHARGING

In its present form the airplane engine is unsuited for self-charging at the higher altitudes since the air pumping occurs too slowly. Modern high-altitude engines are therefore provided with devices for charging the engine at high altitudes, namely, superchargers. Any arrangement that lowers the specific volume of the combustion air before entrance to the engine cylinder is essentially suitable as an airplane-engine supercharger. The most suitable arrangement will be that which combines the highest efficiency with the minimum bulk and weight - that is, which pumps in the required air at the fastest rate. Installations of this type that meet the conditions required are the compressors and the "dynamic pressure superchargers;" i.e., those utilizing the forward velocity of the airplane.

From the point of view of economy in the utilization of energy, three types of superchargers are distinguished: 1) those whose driving power is derived from the gross out-

*"Die Gestaltung von Flugmotorenladern." Luftfahrtforschung, vol. 14, nos. 4/5, April 20, 1937, pp. 244-253.

put of the engine; 2) those which utilize a source of energy that would otherwise be lost (for example, the exhaust heat of the engine) and thus impose no additional load on the engine; and 3) those that are separately driven.

High efficiencies of the supercharger installations should always be aimed for. They are of decided importance for such power units as give high propulsive outputs at high altitudes and so, for example, at 8 kilometers altitude (25,000 feet) still require an inlet manifold pressure of 1 atmosphere. Figure 1 shows the outputs available for an unboosted engine at various supercharger efficiencies at altitudes up to 12 kilometers (39,000 feet), the sea-level output being taken as 100 percent. The increase in engine output through the decrease in the exhaust back pressure has not been taken into account since it depends partly on the valve timing and is of no significance for comparison. The output relations of the engine between zero altitude and the corresponding critical altitude (altitude at which 1 atmosphere pressure can still be maintained) are not shown since they depend on the design of the engine, the admissible duration and degree of supercharging, and the regulation of the supercharger, and these factors are all very different. The supercharger efficiency may also be of great importance for the knock-free operation of the engine. The supercharger air temperatures which, with various supercharger efficiencies, are set up at the different critical altitudes, are also shown on the figure to indicate the possibilities of safe engine operation. If a temperature of 80° C. is considered as the highest admissible supercharger temperature at which the engine will still run without knocking, then the admissible critical altitudes without supercharger air cooling will be given by the curve of figure 2 as a function of the adiabatic supercharger efficiency.

Of the three different designs of superchargers, namely, the piston, the Root's, and the centrifugal types - the centrifugal type possesses today the greatest importance, since attempts to develop the piston and Root's types with satisfactory operating characteristics have so far failed. It even appears doubtful whether there exists any necessity for creating other supercharging machines than the centrifugal types. Two types of wheels are used with the centrifugal superchargers, namely, the radial and the axial wheels. The latter have, up to the present time, attained no marked success since the advantage of good efficiency is

offset by the disadvantages of small pressure heads per stage, difficulties in manufacturing and in safe operation of the very thin blades, the low critical speeds of the multi-stage arrangements, and the difficulty in mounting when engine driven. In what follows therefore, only centrifugal superchargers with radial wheels will be considered. At adiabatic compression without losses the delivery or pressure heads, pressure ratios, and temperatures for these wheels are shown on figure 3.

II. CHARACTERISTICS AND PERFORMANCE OF VARIOUS CENTRIFUGAL SUPERCHARGERS

The wheel with buckets or blades open at both sides (fig. 4a) is probably the oldest form of impeller. The radial blade type with 90° exit angle has not been departed from in supercharger design because of the necessity of high peripheral velocities and pressure rise per stage, although this form of blade compared to the backward curved blades has disadvantages in operating conditions and efficiency.¹⁾ An advantage of the blade open at both sides is the elimination of axial stresses on the bearing. An improved wheel form has also been applied in Germany, whereby the blades receive short radial ribs on their rear sides. In DVL tests on a steel impeller of this type, the peripheral velocity could be raised for short-time intervals²⁾ to 605 meters per second (120,000 feet per minute) without the setting up of a permanent expansion.

The half-open impeller (fig. 4b) is the type applied in by far the greatest number of new engine superchargers. The construction materials are high quality aluminum alloys.

1) On the question of the effect of an exit angle of 90° on the efficiency, the reader is referred to the paper "Untersuchungen über den Einfluss des endlichen Schaufelabstandes in radialen Kreiselladern," by O. Hansen, Braunschweig 1936, who shows that in spite of the increase of the delivery pressure with increasing exit angle, the efficiency need fall off only an insignificant amount.

2) Longer operation was impossible on account of the too high sliding velocities in the bearings.

The wheels may be milled for peripheral velocities up to 250 meters per second (50,000 feet per minute), while for greater velocities they may be stamped, using special dies. The wheel disks are generally provided with cut-outs between the blades. The reason for this is generally given as a lowering of axial thrust and advantages in regard to strength. No extensive investigation on the alleged usefulness of these cut-outs, which in many cases have been the starting points for failures, is available. A DVL impeller which showed up well in a test beyond a peripheral velocity of 400 meters per second (80,000 feet per minute) does not have the cut-outs since theoretical investigations do not show any advantage in regard to the stress distribution.

Impellers having side walls on both sides (fig. 4c) have up to the present been applied to airplane-engine superchargers only in isolated cases. Wheels that are produced by riveting or welding offer particular difficulties in the matter of accurate prediction of stresses and deformations, raise greater difficulties at high peripheral velocities, and mostly have the disadvantage of rough flow passages. A special form of closed impeller is that of Junkers (fig. 5). No test data are available on the parts lying between the individual flow passages - that is, on the outflow - which does not fill out the entire circumference and is thus associated with exchange losses (reference 1). The DVL impeller shown on figure 6 seeks to remove the mechanical difficulties of the closed impeller for very high peripheral speeds through a special construction. The outflow can take place all along the entire circumference. The axial width of the flow passages may vary in an arbitrary manner. In over 100 operating hours of the test supercharger (fig. 6) at peripheral speeds up to 400 meters per second, no failures or permanent deformations of the closed impeller occurred.

Comparison tests have brought out the advantage of this design as compared with the half-open impeller. Figure 7 shows part of the results obtained. The half-open wheel with its required cover clearance $a = 1$ mm (fig. 8a) has a 5-percent-less efficiency than the DVL wheel. Attention is brought to a particular advantage of the impeller closed at both sides, which advantage will some day lead to the general application of this type of impeller.

As the critical altitudes increase, resort to multi-stage centrifugal superchargers becomes necessary. There

will then be difficulties with several half-open impellers on a rather long shaft in a single housing and at the various amounts of heating, in keeping the clearance a (fig. 8a) between the blade edge and the casing wall within favorable limits, a factor which has an important effect on the efficiency. This clearance a may have the greatest effect on the delivery head and efficiency (figs. 8b, 8c). This effect vanished only at a certain operating condition which as yet cannot be predicted by computations (line M-N, figs. 8b, 8c).

Of great significance for the delivery pressure and efficiency of an impeller is the entrance form of the blades. Wheels with radial blades without curving at the inlet give smaller efficiencies and pressures than blades having good entrance curvatures. Figure 9 gives an idea of the order of magnitude of this effect as found from a series of tests. It may be assumed, as known, that the forms obtained by bending the entrance edges of the blades are in most cases conditioned more by the properties of the material than by the requirements from the point of view of flow theory. This unfavorable condition may be remedied by separating the curved blades from the wheel itself, using a special outside impeller (fig. 6). The blades on this separate impeller may be produced by curving or milling by the special Kopier process or the impeller may be built up out of individual blades as in the case of steam-turbine blades. By exchanging the outside impellers the amount of air delivered by the supercharger may within certain limits be suited to the engine.

One method of maintaining straight radial blade leading edges is by imparting the necessary spiral motion to the flow before entrance into the impeller. Without counting the drop in the pressure head per stage introduced by this method, there are no test data available on the advantageous design of inlet guide or diffuser arrangements of this type. Fully satisfactory operation is not attained with an inlet spiral.

In the majority of in-line engines an exit spiral with or without a guide-vane ring finds application while in the case of radial engines the superchargers have only exit guide vanes and a connected vortex space. From the results of numerous tests it may be concluded that to obtain great delivery pressures and efficiencies, guide vanes and a spiral should be provided. Flat characteristics, particularly in the case of too narrow spirals, may sometimes be attained by dropping the guide vanes (fig. 10).

The forms of exit guide vanes, their construction, and the dimensioning of the spirals differ very greatly and sometimes so unsuitably that low efficiencies are not to be wondered at. The superchargers investigated by the DVL of foreign airplane engines had efficiencies of 0.26 to 0.55 for delivery heads between 600 and 3,700 meters (1 meter air column = 1.2-1.25 mm Hg). From the test results it was seen that the energy conversion in the guide vanes was only slight and that the inlet housing was too narrow and provided with too sharp deflections.

III. REQUIREMENTS AND TRENDS OF SUPERCHARGER DEVELOPMENT

An urgent problem requiring solution is that of increasing the delivery pressure attained with a single impeller stage. For the solution of this problem two ways lie open: first, increasing the delivery pressure of a wheel with given peripheral speed, and second, increasing the attainable peripheral speed. For the case of flow entrance without rotation and a 90° blade exit angle, the first possibility may be judged from the equation (see reference 1):

$$H_{ad} = q_{ad} H_{th\infty} = \eta_h \frac{1}{1 + \frac{\psi}{z} \frac{r_2^2}{S}} \frac{u_2^2}{g}$$

where ψ is a coefficient empirically determined, z the number of blades, and $S = \int r dx$ is the static moment of the mean streamline. The decrease in ψ and the increase in η_h depend largely on suitable inlet and exit arrangements which will be further considered below. An increase in the number of blades z (see fig. 11a) is only possible to a limited extent since a large number of blades running up to the hub strongly decreases the inlet cross section and may raise the inlet losses. The method of inserting shorter intermediate radial blades raises difficulties as regards strength requirements and proper design. Tests have shown, however, that an increase in the delivery head may be obtained as the number of intermediate blades is increased (fig. 11b), although at the cost of a lowered efficiency.

An important factor to be considered is a sufficiently large ratio between exit and inlet diameter, which ratio

should lie between 1.6 and 2.2. This requirement raises difficulties at large critical altitudes if, in order to attain smaller dimensions - i.e., higher rotational speeds - the exit diameter is not to be excessively increased. Figure 12 shows the necessary impeller cross sections of the first wheel of a supercharger for altitudes between 6 and 20 kilometers (3.73 and 12.43 miles) for equal inlet and exit velocities. From about 16 kilometers (9.94 miles) on, unsatisfactory wheel forms are obtained although the inlet velocity is 0.5 of the value of the velocity of sound a^* . Any increase in the exit diameter of the wheel with decrease in angular velocity is opposed by considerations of keeping small the wheel friction load (fig. 13), the size, the weight, and the gyroscopic forces.

Increasing the delivery head per stage by raising the peripheral velocity is possible only within restricted limits. There are difficulties in securing good efficiencies. Raising the peripheral velocities brings about a simultaneous increase in the absolute velocity of the air at the impeller exit. This absolute velocity may attain the velocity of sound, giving rise when using exit guide vanes, to well-known difficulties. Figure 14 shows for various operating conditions the computed relations between the absolute velocities at the impeller exit, the peripheral velocity, and the velocity of sound.

Special difficulties may arise on the application of wheels of light metal alloys with hub bore on account of the expansions of the hub bore due to the low modulus of elasticity - these expansions, as shown by computation, amounting to about 0.5 to 0.8 millimeter at a peripheral velocity of 350 meters per second and usual rotor wheel dimensions. In the case of steel wheels there is the possibility of making the wheel and shaft of one piece or shrinking the wheels with great initial stress on to the shaft. Whether shrinking is possible and suitable in the case of light-metal construction, has not yet been investigated. With a suitable design the hub bore, also in the case of light-metal wheels, may be dispensed with if the wheel disk and shaft are of one piece and steel strengthening bushes are fitted about the shaft. Wheels of this type developed by the DVL gave no difficulties in test operation.

Hand in hand with the increase in the delivery head of a single-stage supercharger, there must be an improvement in the operating characteristics, an increase in the efficiency, and an improvement in the regulation possibilities of the engine-driven supercharger.

Operating characteristics and efficiency may be improved by simple means in the design. In many designed superchargers the inlet casing is so formed that there is either no rotation-free flow (fig. 15a) or no uniform admission to the wheel (fig. 15b). The most suitable inlet is under all conditions the straight radial one (fig. 15c) which also had the advantage over the other forms in tests. Where this inlet is not possible on account of mounting difficulties, a similar action may be obtained by means of an inlet housing illustrated in figure 15d. Investigations on engine installations showed that the slight increase in the length of the structure leads to no difficulties.

The form of the delivery head curves as well as the efficiency curves may be affected by the exit guide or diffuser arrangements. In the investigations so far conducted, steep characteristics were always the result of too narrow guide arrangements and housing. Figure 16a shows the H_{ad} and η_{ad} curves as affected only by the form of the guide vanes (fig. 16b). The flattest form of the H_{ad} and η_{ad} curves was obtained in later tests with smooth guide ring of relatively large radial extension with connected concentric annular space. Figure 17 shows that with proper dimensioning of a supercharger, delivery heads of 8,200 meters at adiabatic efficiencies of 0.70 may be attained with a single stage. The size of the experimental supercharger for a spark-ignition engine of about 1,100 horsepower is compared in figure 18 with a modern American supercharger for 3,700 meters delivery head at $\eta_{ad} = 0.53$ and smaller engine output.

Above 6 kilometers the necessary adiabatic delivery head for charging to 1 atmosphere, is greater than the altitude of flight - becoming, in flight at 20 kilometers altitude, 1.65 times the flight altitude. The number of stages to be considered for charging to 760 mm Hg for the various altitudes should lie within the region indicated on figure 19.

With the multi-stage compressors required beyond about 8 kilometers, difficulties arise which do not occur with the single-stage design. In addition to the difficulties of keeping the rotational speed below the critical speed of the impeller, there is also the problem of axial thrust, particularly with the usual designs (fig. 20a), and the measures to be taken for controlling it or removing it.

The simplest method that lies open is that of the counter-flow arrangement of the wheels, as indicated on figures 20b and 20c for the case of a two-stage supercharger. The application of the labyrinth piston familiar in the design of stationary compressors may meet with space and weight difficulties. The light construction of the casing and the resulting size of the labyrinth clearances raise the danger of too great leakage losses. For taking up the axial thrust mechanically, roller bearings of the high shoulder type of construction, and special journal bearings, may within certain limits find application. The necessity of bringing up and cooling large quantities of oil, is a disadvantage of the journal bearing since the problem of oil cooling, as every cooling problem at high-altitude operation, is a difficult one and moreover, any entrance of oil carried along with the supercharged air into the inter-cooler, would in a short time reduce the effectiveness of the latter.

Studies made on suitable designs indicate that the arrangement of opposed flow stages is the most suitable for multi-stage compressors, particularly if the compression process must be interrupted for the purpose of inter-cooling. A sufficiently high critical r.p.m. in below-critical operation may be attained by using powerful shafts, intermediate bearings, and low operating speeds. Obviously, these measures are at the expense of increased weight. The question as to whether below-critical operation is necessary or whether safe flight operation may be attained at appreciably above the first and sufficiently below the second critical r.p.m. of the wheel, depends essentially on the very wide regulation range of the supercharger at high altitude operation. As long as the superchargers are driven by the engine, the questions of gearing and regulation give rise to difficulties at the high delivery heads of the superchargers. At constant ratio between the supercharger and engine r.p.m., even with good supercharger efficiencies, the supercharger temperatures attain excessive values at low altitudes, and on account of the strong throttling required, make a sufficiently high take-off power difficult or even engine operation itself, impossible. The multispeed gear offers some remedy for the time being. The stageless or infinitely variable regulation of the supercharger speed has been investigated by the DVL and may no longer be considered as an unsolved problem. An experimental arrangement which quite approached the stageless zero-loss regulation, gave satisfactory results.

Further possibilities of regulation in the case of gear-driven superchargers that show promise are, for example, the regulation of the admission of multistage superchargers. The installations required are simply cut-off devices at the entrance and exit of one or more impellers and additional inlet openings in the housing as the case may require. If the cut-off members are so designed that they give a sufficiently tight cut-off, and if their action takes place in suitable sequence, then by connecting and disconnecting entire wheels and using partial throttling, an almost stageless regulation of the supercharger pressure to correspond to the altitude of flight may be attained.³⁾ Although this method of regulation has not yet been investigated in operation the difficulties associated with it appear capable of solution since the parts to be controlled may be situated at the fixed housing and thus have an advantage over gears that have to be thrown in and out at high speeds. With exhaust turbine-driven superchargers, the difficulties in the r.p.m. regulation described, do not appear.

IV. SOME PRINCIPLES FOR THE COMPUTATION OF SUPERCHARGERS

The supercharger investigations so far conducted by the DVL, have shown that the familiar computation methods applied in the case of centrifugal compressors yield, without any appreciable modifications, good results also in the case of the unusual conditions of airplane-engine supercharger design. The inlet velocities at the impeller may assume high values. A limit is set by the consideration that too close an approach to the velocity of sound leads to the appearance of separation phenomena of the air flow. The ratio of the inlet velocity to the velocity of sound lies in most cases within the range 0.2 to 0.3 but may be further increased.

Since the wheel blades at the wheel inlet have the form of axial blades near the hub the entrance deflection, i.e., the necessary setting of the blades should not be left out of account in the computation of the angle at the blade entrance on account of the relatively great blade

³⁾ A closer investigation of the economy of this method which depends essentially on the proper dimensioning of the cut-off devices and on the additional quantities required for cooling would lead us too far afield.

separation, particularly at the maximum inlet diameter. The test data available justify the assertion that with proper application of familiar computation processes (see reference 1) satisfactory results may be obtained. The investigations have furthermore shown, with relatively good agreement, that with sufficiently large outlet guide arrangements the quantity delivered with shock-free entrance V_{st} - that is, that which would be delivered if the direction of the relative flow coincided with that of the first blade element - stands in approximately constant relation to that corresponding to the maximum efficiency $V_{\eta_{max}}$.

Although the value is only an approximation, it is not unimportant to know in the case of new designs that with the diameter ratios and number of blades usual in present-day design the quantity $V_{\eta_{max}}$ is 1.3 to 1.7 times as large as V_{st} . Tests on this effect are lengthy since every change in the wheel entrance also requires a change in the wheel exit diffuser. The tests have nevertheless been partially carried out using the impellers shown on figure 6.

An essential difficulty in the design of a new impeller for a required pressure lies in the computation of the effect of the finite number of blades. The number of blades fluctuates in the case of the straight radial bucket arrangement between 10 and 20. The figure of merit q_{ad} which is the ratio between the delivery head $H_{th\infty}$ (which would be obtained with frictionless flow with an infinite number of blades) and the delivery head actually obtained (which is to be computed at compression without cooling from the measured initial and final values of the pressures, temperatures, and quantity delivered):

$$q_{ad} = \frac{H_{ad}}{H_{th\infty}} = \frac{\frac{k}{k-1} R T_I \left[\left(\frac{p_{II}}{p_I} \right)^{\frac{k-1}{k}} - 1 \right] + \frac{c_{II}^2 - c_I^2}{2g}}{\frac{u_2^2}{g}}$$

and for which, with different superchargers, the values shown on figures 21a and 21b were found, is not sufficient for the computations since it includes to a great extent the effect of the exit guide arrangements and the housing. With the values $H_{th\infty} = m H_{th}$ and $H_{th} = 1/\eta_h H_{ad}$ there is obtained $q_{ad} = \eta_h/m$. From extensive measurements and computations values were found for η_h between 0.82 and

0.86 so that it appears possible to give figures also for m . If m is split up according to the previously given equation, values of ψ are found between 2.0 and 2.4. New designs that were computed with these values for various superchargers led to results that gave good agreement with the precomputations. The form of the flow passages was so designed that the meridian component of the absolute velocity, on the assumption of completely filled blade passages between inlet and outlet of the wheel, remained approximately constant or decreased slightly. The maximum values of ψ were found when the exit guide passage was of small radial extent. With a supercharger size such as appears necessary and also admissible from the point of view of space and weight saving, the values of the peripheral velocities u_2 at the critical altitudes shown in figure 22 should be attainable.

For the correct computation of the guide vanes and spiral behind the wheel exit assumptions must be made regarding the compression that took place up to the rotor wheel exit. For the above-mentioned case of $c_0 = c_{2m}$ and for a frictionless process with infinite number of blades, we have:

$$H_{kin_\infty} = H_{th_\infty} - H_{stat_\infty} = \frac{c_2^2 - c_0^2}{2g} = \frac{c_2^2 - c_{2m}^2}{2g} = \frac{c_{2u}^2}{2g}$$

and for $\beta_2 = 90^\circ$, i. e., $u_2 = c_{2u}$

$$H_{kin_\infty} = \frac{u_2^2}{2g}$$

The degree of compression with infinite number of blades would then be

$$\rho_\infty = \frac{H_{stat_\infty}}{H_{th_\infty}} = 0.5$$

On account of the exit deflection the theoretical absolute velocity is greater than the actual ($c_2 > c_3$) and correspondingly $c_{2u} > c_{3u}$. Taking account of a finite number of blades and writing

$$H_{stat\ th} = H_{th} - H_{kin\ th}$$

where $H_{th} = \frac{u_2 c_{3u}}{g}$

and

$$H_{kin th} = \frac{1}{2g} (c_3^2 - c_{3m}^2) = \frac{c_{3u}^2}{2g}$$

we find

$$\rho_{th} = 1 - \frac{c_{3u}}{2u_2}$$

With $H_{th\infty} = m H_{th}$, i.e., $c_{2u} = m c_{3u} = u_2$

we find

$$\rho_{th} = 1 - \frac{1}{2m}$$

For various assumptions the values obtained by computation are those given in figure 23, which give good agreement with measured values although certain approximations have been made in computing them. Setting the computed value ρ_{th} equal to the actual value ρ corresponds to the assumption of an equal hydraulic efficiency η_h in the rotor and guide wheels.

Exit guide vanes that were computed by familiar methods (see reference 1) gave satisfactory results provided the divergence angle ϵ of the guide passage was designed considerably smaller than what is considered admissible in the literature on the subject. With the guide vane forms so far investigated by the DVL, best conversion ratios were obtained at $\epsilon \leq 4^\circ$. The effect of the exit guide vanes on the form of the characteristic and the magnitude of the supercharger efficiency is very great. Figure 16 shows one example taken from numerous investigations and from which the forms of the guide passages and the results obtained may be seen. The exit spirals of the supercharger have up to the present always been determined by the DVL by the condition of constant rv (where r is the radius, and v the velocity) with the wall friction taken into account. An accurate analytical and experimental investigation on a given spiral gave good agreement between theory and experiment (fig. 24). The values of the constant k determined from the cross sections of the spirals agree quite well with the measured values of the static and total pressures along the outer boundary of the spiral and with the velocity for the same values of the quantity delivered per second.

SUMMARY

Summarizing, it may be said that with the forms of superchargers and underlying principles of computation with which we are familiar today, and with proper utilization of the construction material available, delivery heads per stage of 7,000 to 8,500 meters (air column) at an effective efficiency, based on the adiabatic process, of 0.7 may be attained, the space and weight requirements being kept within reasonable limits. The view held of a supercharger as an inconvenient auxiliary device, is no longer justified at altitudes above 3 kilometers (10,000 feet), since satisfactory operation of the engine is no longer possible without it. It should be the problem of the engine designer to see that with given high pressures and efficiencies the size and weight of the supercharger are kept as small as possible. That a bad mounting arrangement of an engine is not always to be attributed to too large a supercharger may clearly be seen from the example of the Rolls-Royce Kestrel engine which, in spite of a large supercharger, may be mounted in an efficient manner. The question as to whether the common present arrangement of the supercharger on the engine side, away from the propeller, should be maintained cannot as yet be definitely answered.

Translation by S. Reiss,
National Advisory Committee
for Aeronautics.

REFERENCE

1. Pfleiderer, C.: Die Kreiselpumpen. 2. Auflage.
Julius Springer, Berlin, 1932.

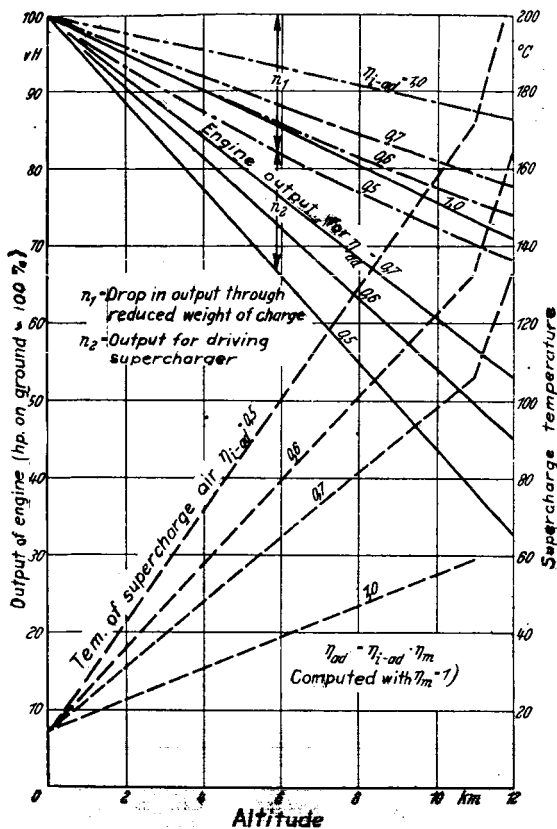

Figure 1.-Effect of supercharger efficiency η_{ad} on the performance of an engine (sea level output = 100 percent) at critical altitudes up to 12 km. (7.5 mi.).

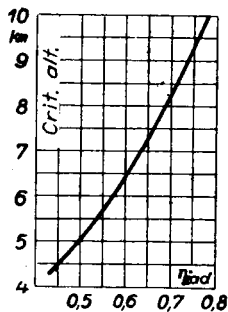

Figure 2.-Critical altitude attainable without intercooling as a function of the internal adiabatic supercharger efficiency η_{1-ad} (Admissible assumed supercharger temperature 80°).

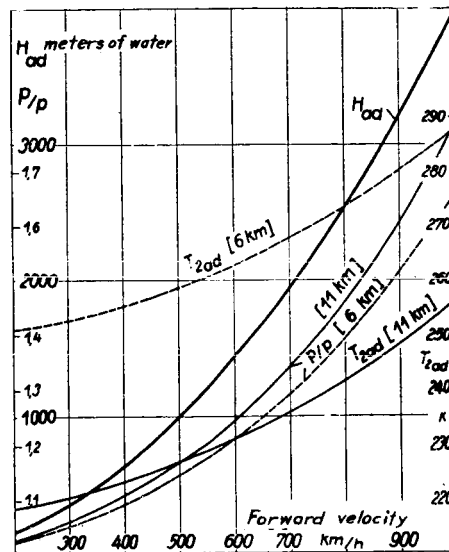
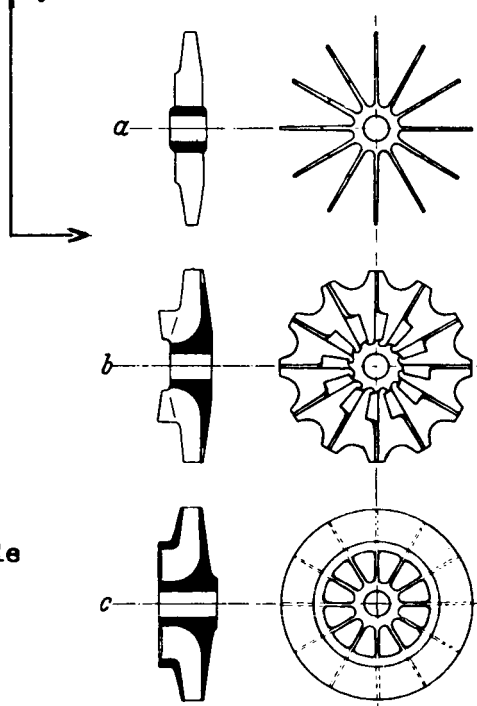

Figure 3.-Variation of delivery heads, pressure ratios, and temperatures with velocity of flight for zero losses, adiabatic compression.

Figure 4.-Types of supercharger impellers.

- a, blades open at both sides,
- b, half-open impeller with side wall at back of wheel,
- c, impeller closed at both sides by walls.



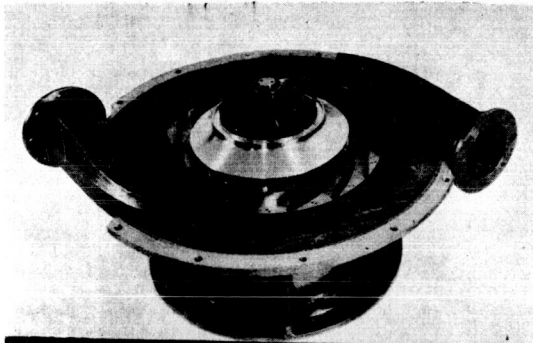

Figure 5.- Impeller of a Junker super-charger.

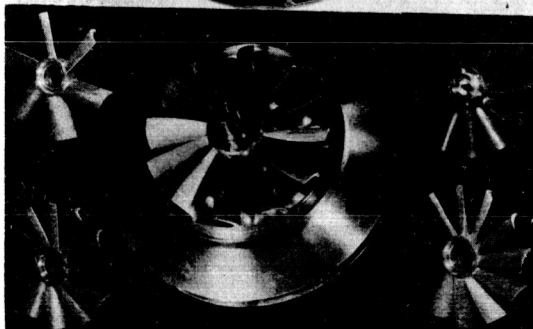
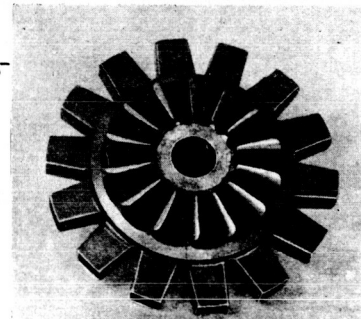

Figure 6.-DVL rotor wheel with separate impellers having adjustable blades and variable spirals.

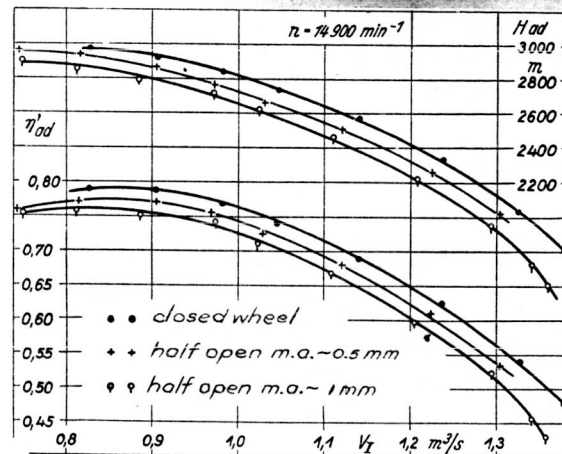

Figure 7.- Comparison of pressure heads and efficiencies of closed and half-open rotor wheels

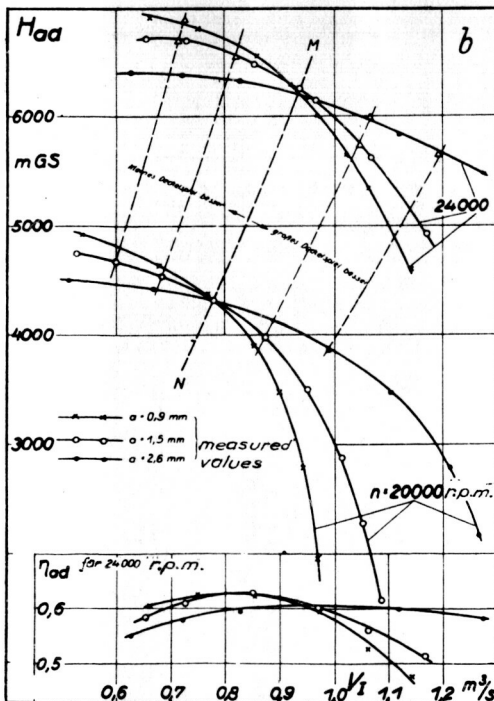

Figure 8b.-Effect of clearance (a) on wheel characteristics with half-open impeller.

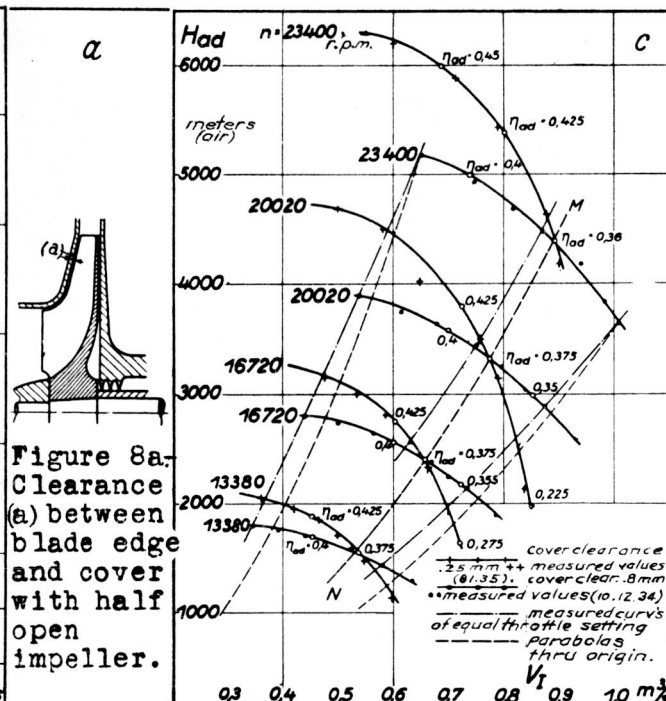

Figure 8a.- Clearance (a) between blade edge and cover with half open impeller.

Figure 8c.-Effect of clearance (a) on characteristics of impeller open at both sides.

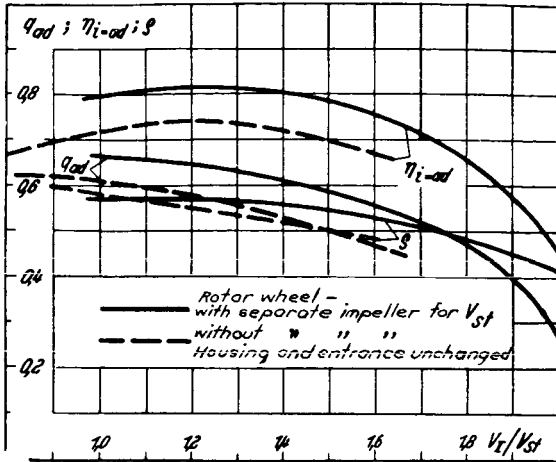

Figure 9.-Improvement in characteristics of a wheel with radial blades by separately added impeller (fig.6).

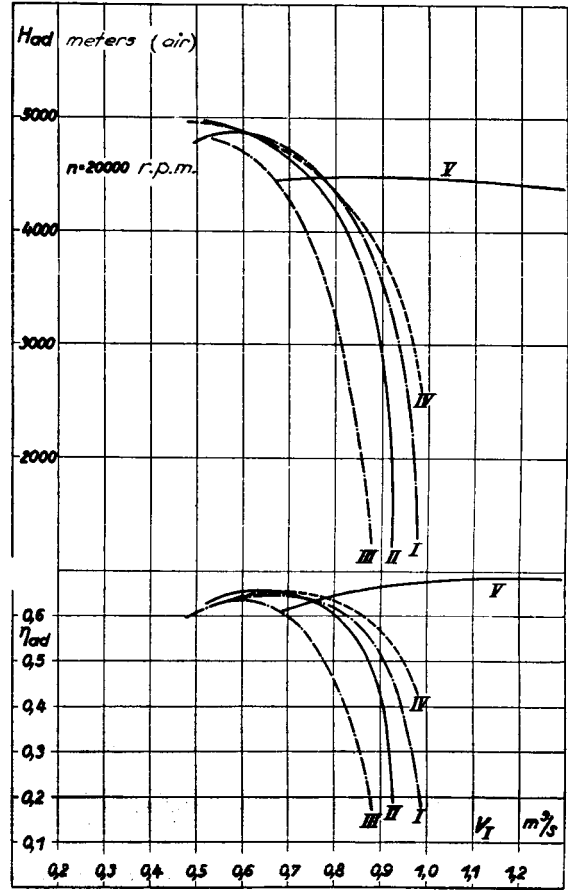

Figure 10.-Effect of form of exit on characteristics of superchargers. Curves I-IV correspond to four different forms of guide vanes. Curve V was obtained with vanes removed. i.e. with smooth guide ring.

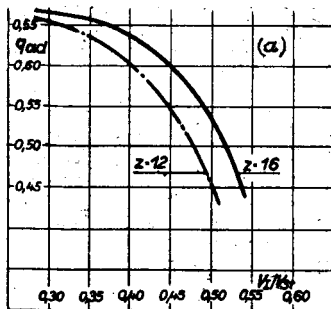

Figure 11a.- Figures of merit for different numbers of blades for same supercharger dimensions.

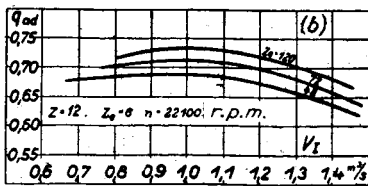

Figure 11b.- Figures of merit for different numbers of intermediate radial blades z_a at rotor wheel exit.

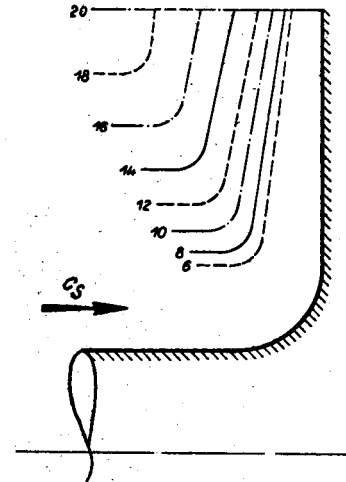

Figure 12.- Impeller cross sections of the first stage of a supercharger for a 600-700 hp. spark-ignition engine. (The numbers correspond to the critical altitudes.) Assumptions: $u_2 = 300$ m/s. $c_s \sim 0.5 a^*$. $c_{2m} \sim 0.7 c_s$

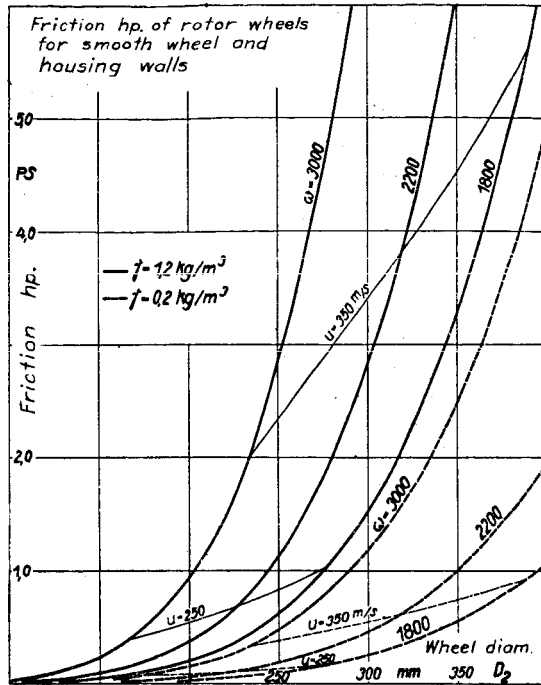

Figure 13.- Friction hp. of impellers for different air densities in the casing and different values of w .

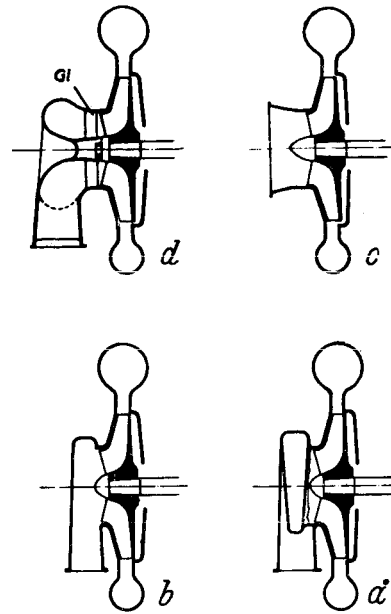

Figure 15.- Common forms of inlet housings.

a, with spiral, b, with inlet chamber. c, with axial entrance. d, with vortex space and short guide vanes G_1 .

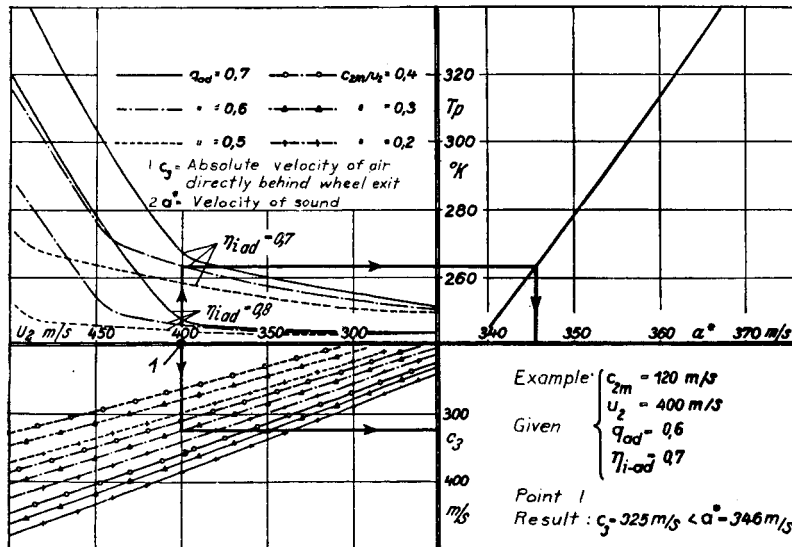

Figure 14.- Computed relations between the peripheral velocity of wheel, absolute velocity of air at rotor wheel exit and velocity of sound for various air temperatures at exit. (The computation is based on measured values of temperatures and pressures. The inlet temperatures correspond to the peripheral velocity and figure of merit of corresponding critical altitude).

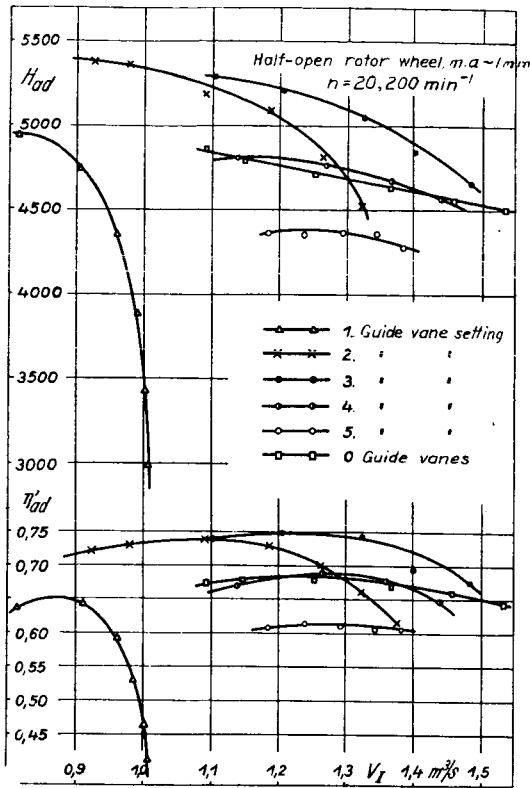

Figure 16a. Improvement in supercharger characteristics by proper diffuser arrangement.

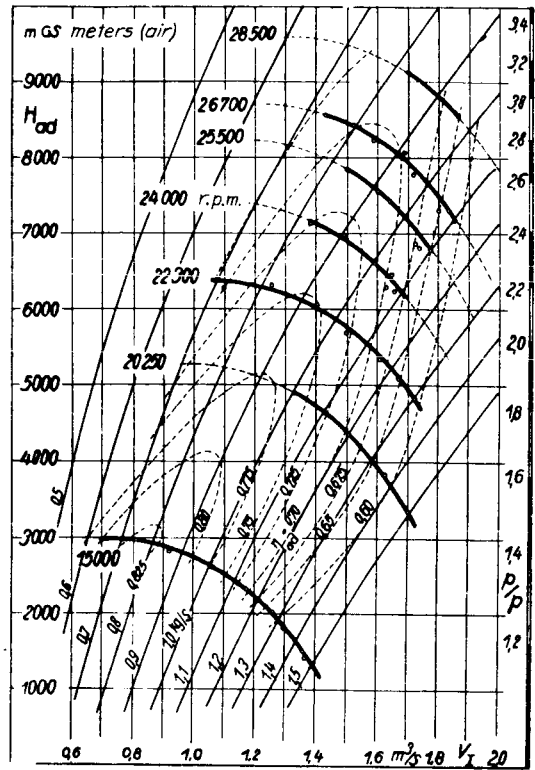

Figure 17. Characteristics of DVL supercharger of fig.6. (—○—○— measured values after a many hour test run).

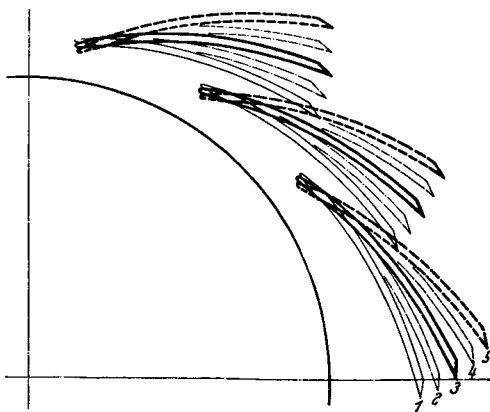

Figure 16b. Guide vane arrangements giving the results of fig. 16a.

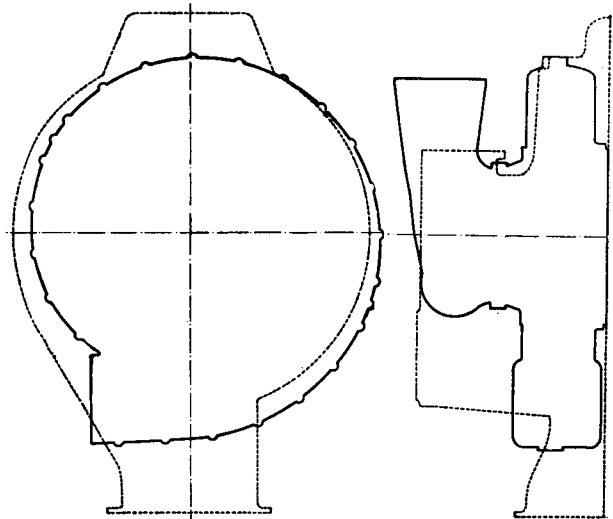

Figure 18. Comparison of dimensions of DVL test supercharger (fig.6) with a modern American supercharger for an in-line engine (----- American, ——— DVL).

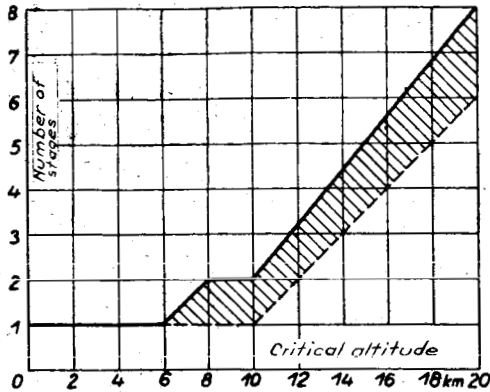

Figure 19.- Number of stages of multi-stage superchargers for critical altitudes up to 20 km. (12.4 mi.)
 ----- Lower limit for present state of development.

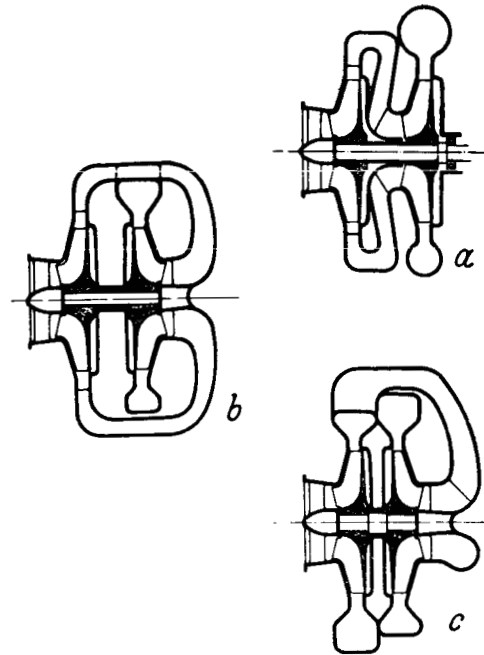

Figure 20.- a, direct flow two-stage supercharger. b, counter flow two-stage supercharger with deflecting space. c, counter flow two-stage supercharger with two spirals.

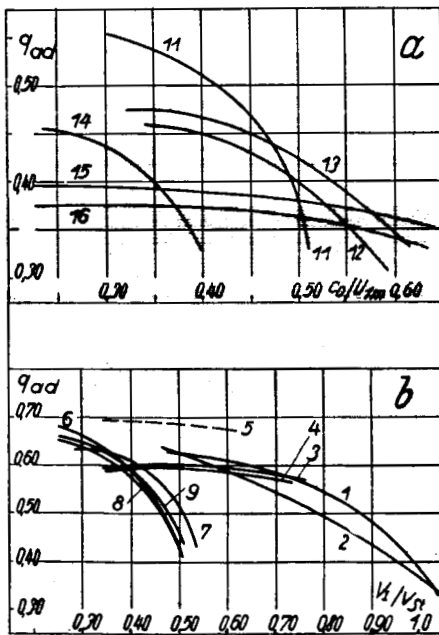

Figure 21.- Values of q_{ad} found for a large number of superchargers investigated.

21a.- Values of q_{ad} as a function of c_0 / u_{1m} for superchargers with straight radial blades. c_0 , inlet velocity to wheel. u_{1m} , peripheral velocity at mean inlet diameter. Curves 11, 12, 13, supercharger of a radial engine with well designed rotor blades. Curve 14, supercharged with bad guide vane arrangement, Curves 15, 16, supercharger with bad exit guide vanes and connecting annular space.

21b.- Values of q_{ad} as a function of V_I / V_{st} with curved rotor blades at inlet, V_{st} , computed quantity delivered for shock-free entrance. Curves 1, 2, supercharger for radial engine with unsuitable guide vanes. Curves 3, 4, 5, supercharger with pressure spiral connected to smooth guide ring of varying radial extent. Curves 6, 7, 8, 9, supercharger with pressure spiral connected to various exit guide vanes.

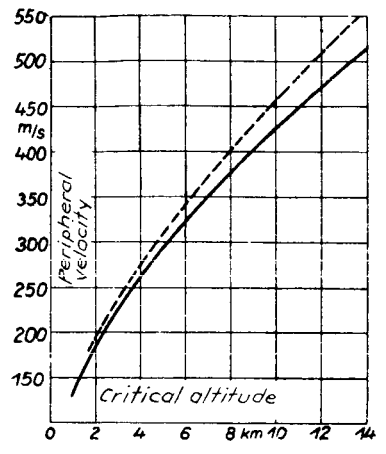

Figure 22.-Relation between peripheral velocity of an impeller and attainable critical altitudes. (-----measured values up to 10 km. (6.2 mi.)

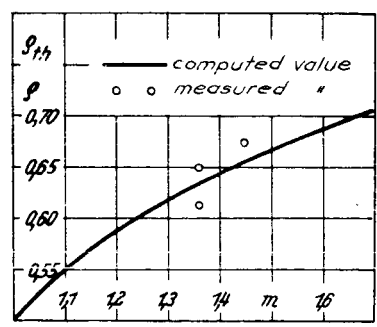

Figure 23.-Computed and measured values for ρ .

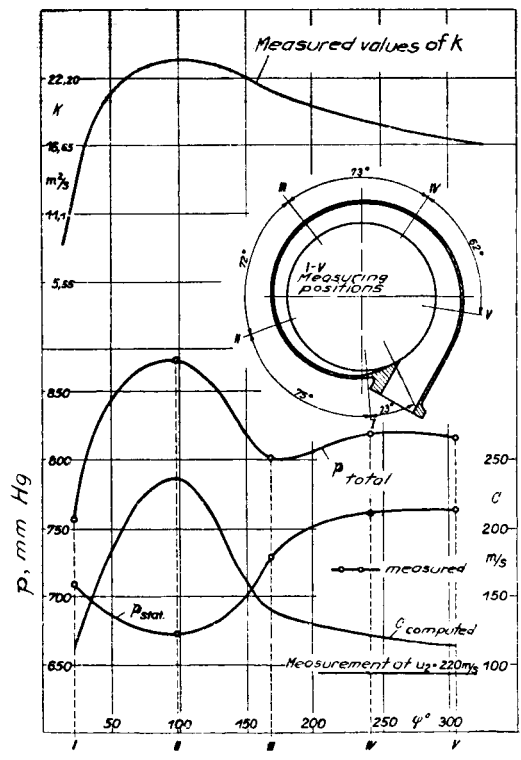

Figure 24. Computed values of k and measured pressures and velocities in a supercharger spiral.